

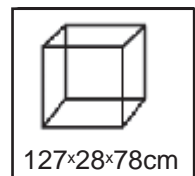

No. 474 - Octopus

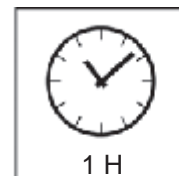

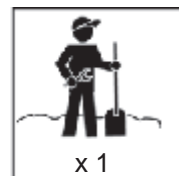

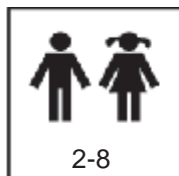
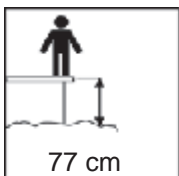
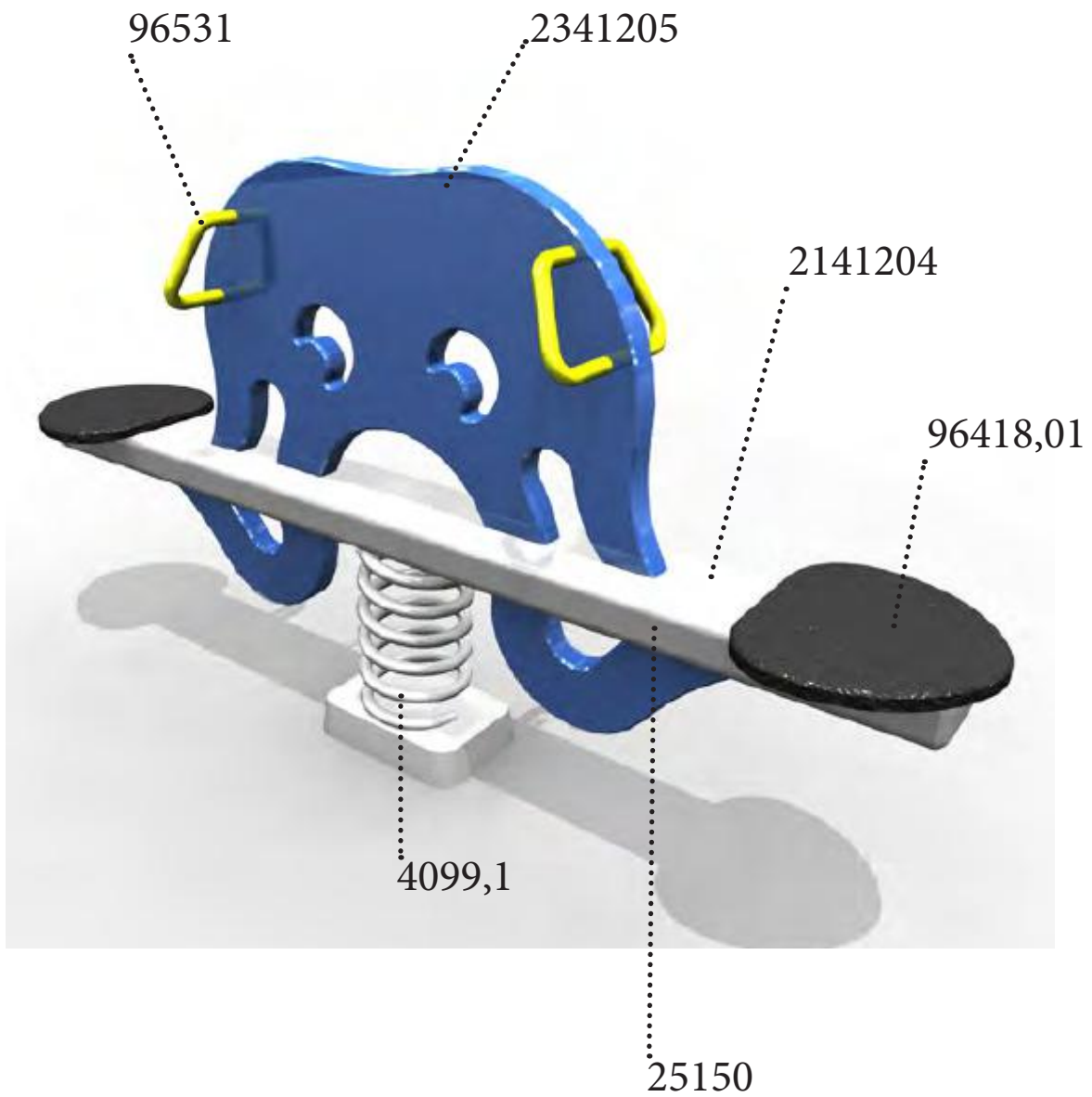

Faldunderlag: I overensstemmelse med EN 1177

Safety surface: In accordance with EN 1177

Fallschutzbelag: Gemäß EN 1177

Zone D'impact d'après norme EN 1177

Fundamento de caída según norma EN 1177

		
(A)	50 cm	14 m2

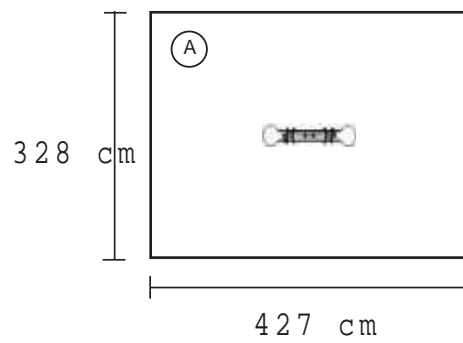

1 : 100 cm

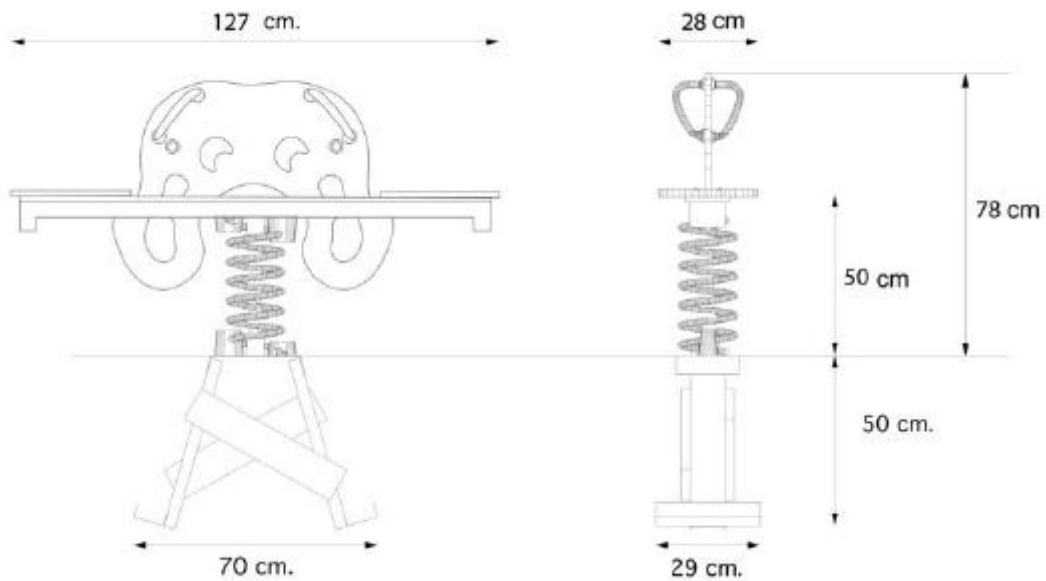



4 Pcs.		GT
2 Pcs.		LM 6
2 Pcs.		M6x16 Pin TX 30
1 Pcs.		TK 30
2 Pcs.		

