

LEDON®

No.443 - Moon

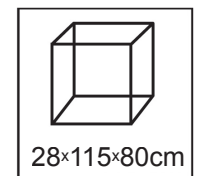

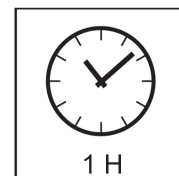

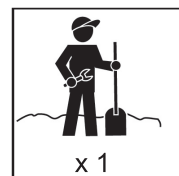
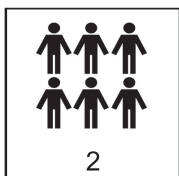
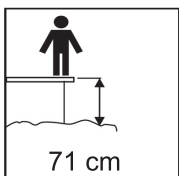
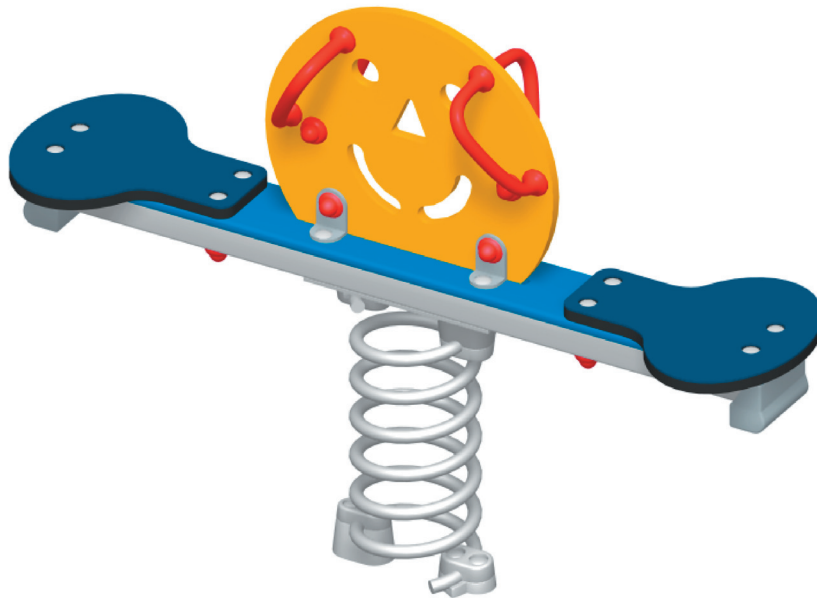
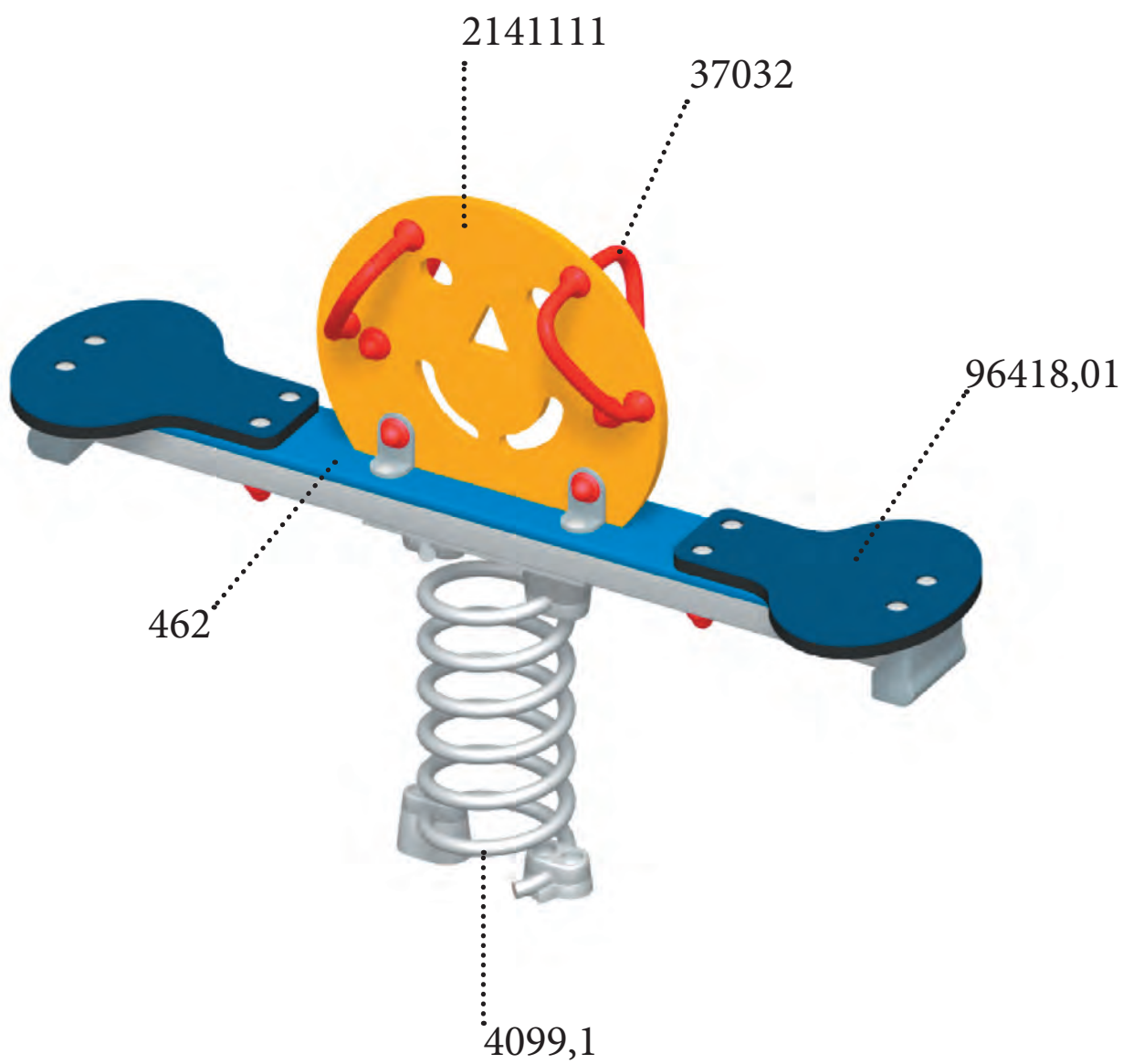

Faldunderlag: I overensstemmelse med EN 1177

Safety surface: In accordance with EN 1177

Fallschutzbelag: Gemäß EN 1177



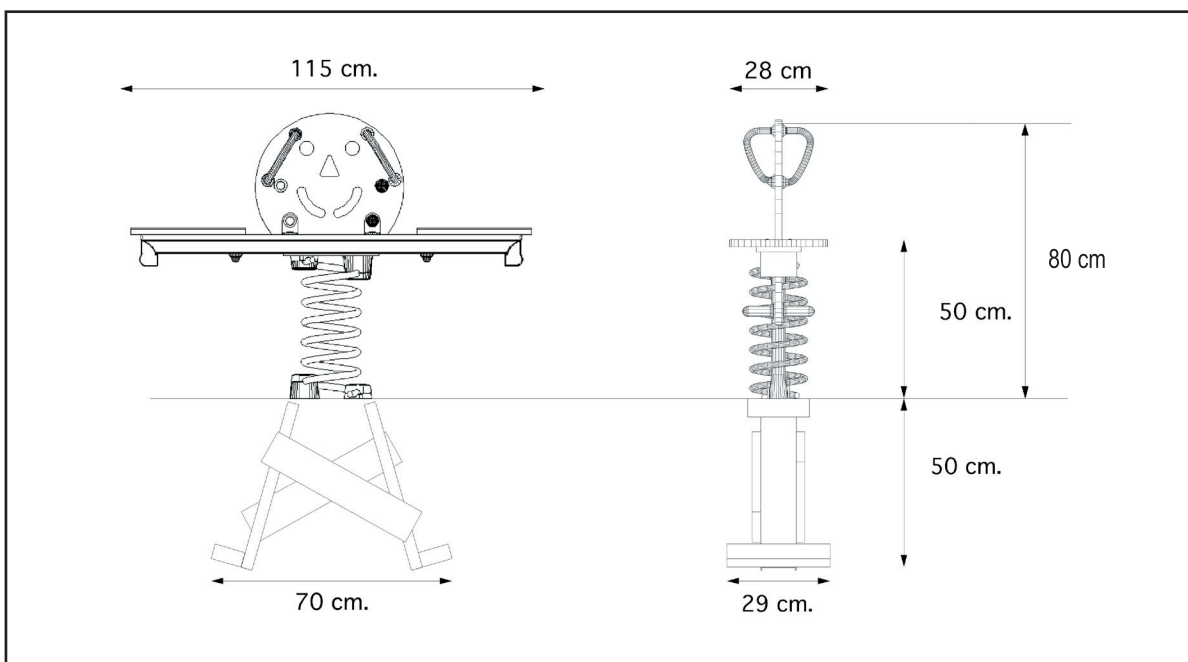
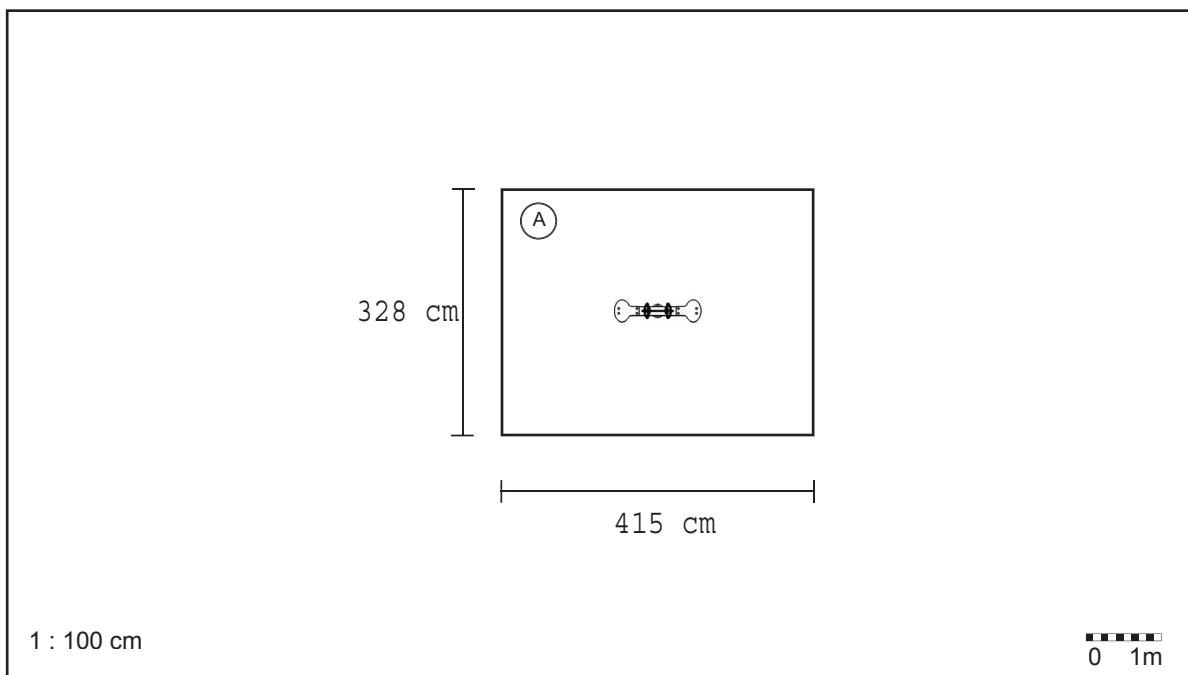

Zone D'impact d'après norme EN 1177

Fundamento de caída según norma EN 1177

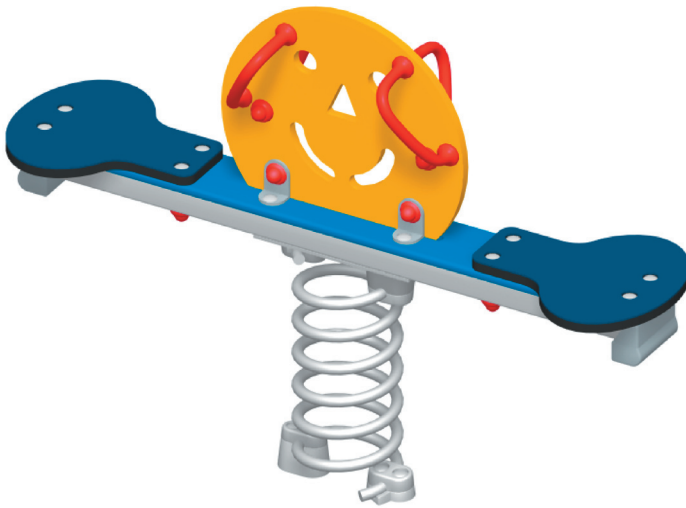
		
(A)	71 cm	13,6 m2





4 Pcs.		GT
2 Pcs.		LM 6
2 Pcs.		M6x16 Pin TX 30
1 Pcs.		TK 30
2 Pcs.	