



Pony Type 430

- Develop the sense of balance
- Stimulate the imagination
- Train gross motor skills
- Encourage social play
- Provide children with a strong sense of cause and effect



PE

Our plates of polyethylene don't splinter, and all joints are gap-free. Which means that neither fingers nor clothes can get caught or ripped.

Springs

Springs of special steel that can take bending in all directions. Designed so that no one can get their fingers caught. Patented suspension with self locking nuts.



Two mounting options: In the ground or on concrete. Cover completes the unit, even when there is no cushioned ground cover. Perfect for use with rubber ground cushion.

Technical data



Space required

1:100

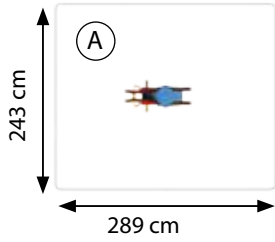

Dimensions

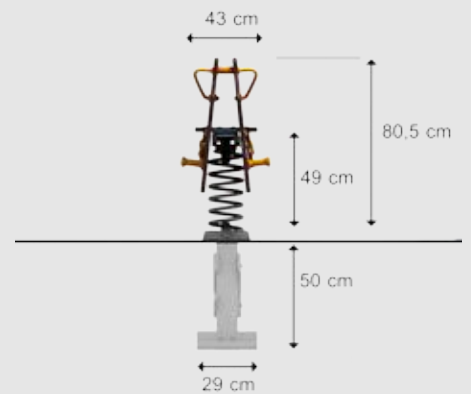

	HCL	m2
(A)	49 cm	7 m2

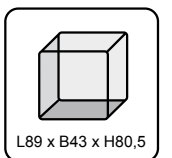
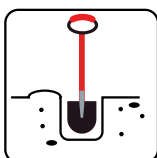
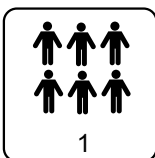
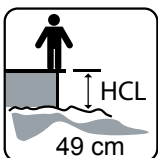

Safe high quality playground...

Springs of special steel that can take bending in all directions. Designed so that no one can get their fingers caught. Patented suspension with self-locking nuts.



All handles, nut caps, foot rests etc are manufactured from impact-proof nylon. The nylon is shockproof between -40° C to + 110° C

All handles have good gripping surfaces and are rounded off, which minimizes the risk of eye and teeth damage. Made of nylon, so the fingers don't freeze to them.



All Poledon-plates are manufactured from environmentally friendly polyethylene (PE) Advantages: No maintenance - non-toxic material - 100% recyclable - scratches and dents do not reduce neither the quality nor the lifetime of the product. All our Poledon-plates are UV stabilized and we warrant a 5-year guarantee against essential fading of the colour. 10 year guarantee against material and production failure.



All horizontal surfaces are covered with rubber to make them skid-proof - car industry technology.



Our plates of Polyethylene don't splinter, and all joints are gap-free. Which means that neither fingers nor clothes can get caught or ripped.



Nut covers cap sharp edges and prevent unwanted removal.



Footrests according to EN 1176



PAK test

Alle synthetic fabrics are testet free of heavy metals by TÜV.

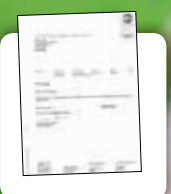

All Ledon play equipment are testet and approved according to the latest specifications of EN 1176 byTÜV.



10 year guarantee against material and production failure. **5 year guarantee** against essential fading of the colours